

## POSH RAPID



**8,000 BHP / 105 TBP / DP2 / AHTS Call Sign: 9V8662**

### Principal Particulars:

Flag	: Singapore
Year Built	: 2011
Place Built	: Paxocean Engineering Zhuhai Co., China
Length Overall	: 71.50 m
Length B.P.	: 61.20 m
Beam Overall	: 16.60 m
Depth Moulded	: 7.20 m
Design Draft	: 4.50 m
Scantling Draft	: 5.90 m
IMO No.	: 9587922
Official No.	: 396075

### Classification:

ABS +A1, Towing Vessel, Fire Fighting Vessel Class 1,  
Offshore Support Vessel, (E), +AMS +ACCU + DPS-2, ES2020

### Capacities:

Gross Tonnage	: 2588 tons
Net Tonnage	: 766 tons
Deadweight	: 1057 tons@4.5m draft : 2457 tons@5.9m draft
Fuel Tank	: 763 m <sup>3</sup>
Potable Water	: 541 m <sup>3</sup>
Drill Water	: 1524 m <sup>3</sup>
Mud Tank	: 448 m <sup>3</sup>
Brine	: 312 m <sup>3</sup>
Foam	: 10 m <sup>3</sup>
Dispersant	: 13 m <sup>3</sup>
Deck Cargo Area	: 450 m <sup>2</sup> (approx. 35m x 12.8m)
Deck Cargo	: 900 tons
Cargo Deck Load	: 10T/m <sup>2</sup> for area abt 160 m <sup>2</sup>
Reefer Points	: 4 (2x440v, 2x220v)

### Speed/Fuel:

Max Speed	: 14 kts
Quality of Fuel	: MGO

### Discharging Rates:

Drill Water/Pump	: 1 x 150 m <sup>3</sup> /hr@75m head
Fresh Water/Pump	: 1 x 150 m <sup>3</sup> /hr@75m head
Fuel/Pump	: 1 x 150m <sup>3</sup> /hr@70m head
Brine/Pump	: 1 x 100 m <sup>3</sup> /hr@204m head
Liquid mud/Pump	: 1 x 100 m <sup>3</sup> /hr@204m head
Loading Computer	: Bridge control
Flow Meter	: 1 for FO with printer output

### Bulk Plant:

249.2 m<sup>3</sup> in 4 tanks (  
Working pressure 6 bar; Refrigeration Air Dryer units

### Accommodation:

Officer/Crew	: 17
Berth Total	: 40 (1manx4, 2menx4, 4menx7)
Cabins Total	: 15
Hospital	: 1
Air conditional throughout	

### Machinery & Equipment:

Main Engines	: 2 x MAN B&W 8L27/38, total output 2 x 3,970BHP @ 800RPM
Generators	: 2 x 1200kW Shaft generators Leroy Somer @440V 3Ph 60Hz : 2 x 370kW diesel alternators Cat3408C @440V 3Ph 60Hz : 1 x 122kW emergency diesel alternator Volvo Penta @440V 3Ph 60Hz.
Propellers	: 2 x 3.4M CP propellers in fixed nozzles, 2 independent high lift type rudders
Bow Thruster	: 2 x 450kW CP rated 7.1T Tunnel thruster
Stern Thruster	: 1 x 450kW CP rated 7.1T Tunnel thruster
Deck Crane	: 5T Knuckle Boom @ 18m radius (mounted on stbd side aft of accom)

### Tow/Anchor-handling Equipment:

Tow/AH Winch	: 1 x double drum waterfall, low pressure; Stall Pull 200T Brake holding 300T Brake holding capacity @400 tons; Rig Chain size 76mm dia
--------------	--

Wire Drum	: 2 x 1500m each @ 64mm dia wire
Storage Drum	: 1 x 5T @ 0-30m/min 1500m 64mm sw rope
Tugger Winch	: 2 x 10T each @ up to 16m/min
Shark Jaw	: 1 x Triplex H200, SWL 200 tons
Tow Pin	: 1 x Triplex S115, SWL 115 tons
Capstans	: 2 x 5T each @ 0-15m/min
Stern Roller	: 1 x 300 tons SWL, 6m x 2m dia
Grapnel Hook	: 1 x 110 tons
J Hook	: 1 x 110 tons
Wildcats	: 2 units
Chain Lockers	: 2 x 80m <sup>3</sup>

### Towing / AH Wires:

Main Tow Wire	: 1500m x 56mm dia
AH Wire	: 350m x 64mm dia
Spare tow Wire	: 1500m x 56mm dia
Pennant Wire	: 64mmx100m & 64mmx60m with both end aluminium mechanical spliced thimble

### Mooring Equipment:

Windlass	: 10T @ 9m/min for chain cables
Anchors	: 2 x AC-14 Stockless anchors each 2140kg
Cables	: 350m x 38mm dia

### DP/Joystick Control:

Converteam Independent Joystick (IJS) ADP-2 system

### FiFi 1 System/Oil Pollution Control:

2 x 1650m <sup>3</sup> /hr @ 140m head; Class FiFi I, Dispersant	
Foam Tank	: 10.65 m <sup>3</sup>
Dispersant Boom	: 2 x 6m max. turning radius located on port and starboard

### Navigation & Communication Equipment:

HF/FM/Telex	: Furuno FS-2570
VHF fixed	: 2 x Furuno FM-8800S
VHF portable	: McMurdo R2
Inmarsat C	: Furuno FELCOM 15 SSAS
Navtex	: Furuno NX-700B
Autopilot	: SIMRAD AP-50
Radar ARPA	: Furuno FAR 21x7 / FR1510-3
Surface plotting	: Yes
DGPS	: Furuno GP-150
Gyro	: SIMRAD GC 80
Echo Sounder	: Furuno FE 700
AIS Transponder	: Furuno FA 150
Speed Log	: Furuno DS-80
GMDSS Radio	: 3 pcs, McMurdo R2
Magnetic Compass	: SAURA Keiki Seisakusho

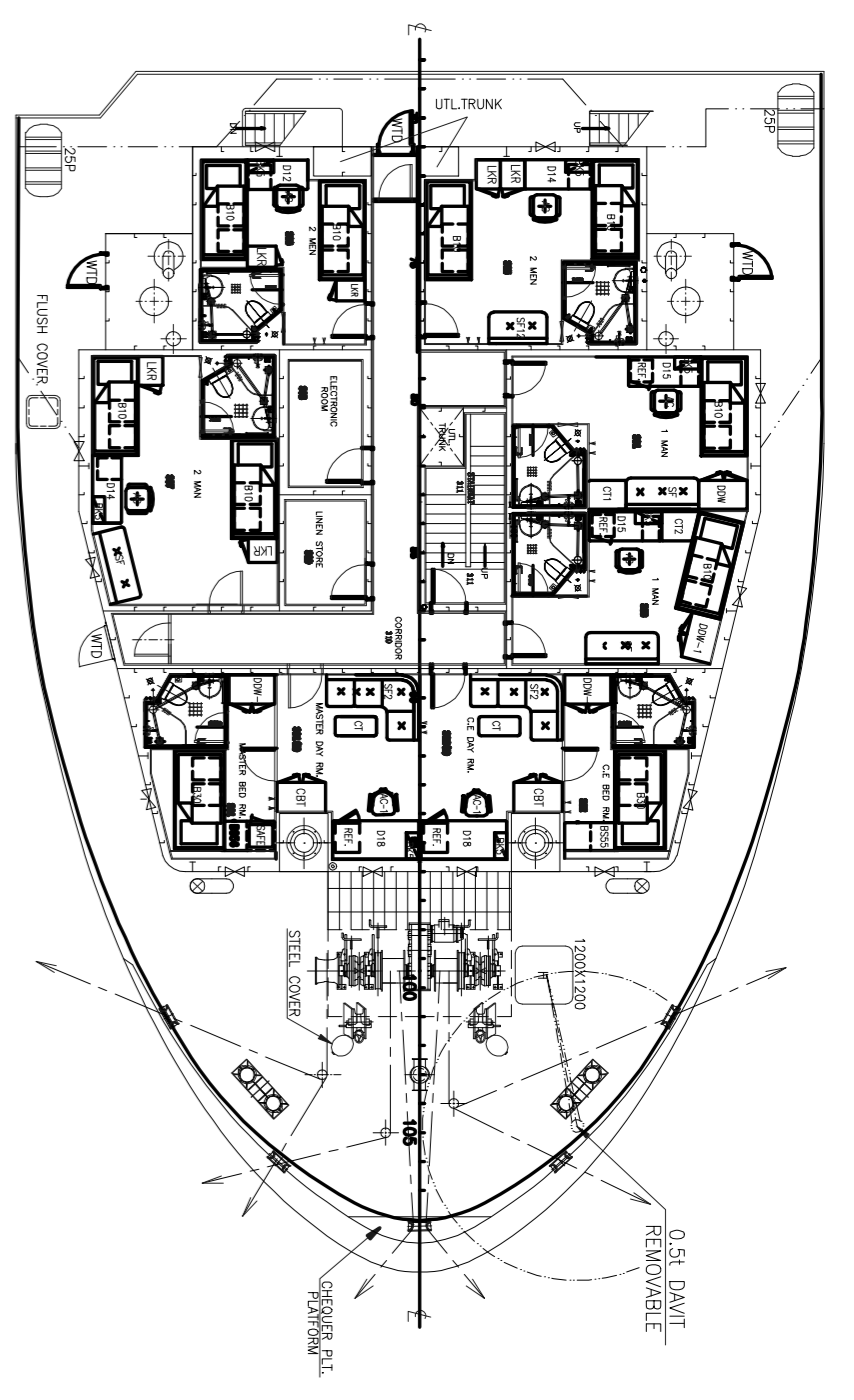

UPPER FORECASTLE DECK (10PAX)

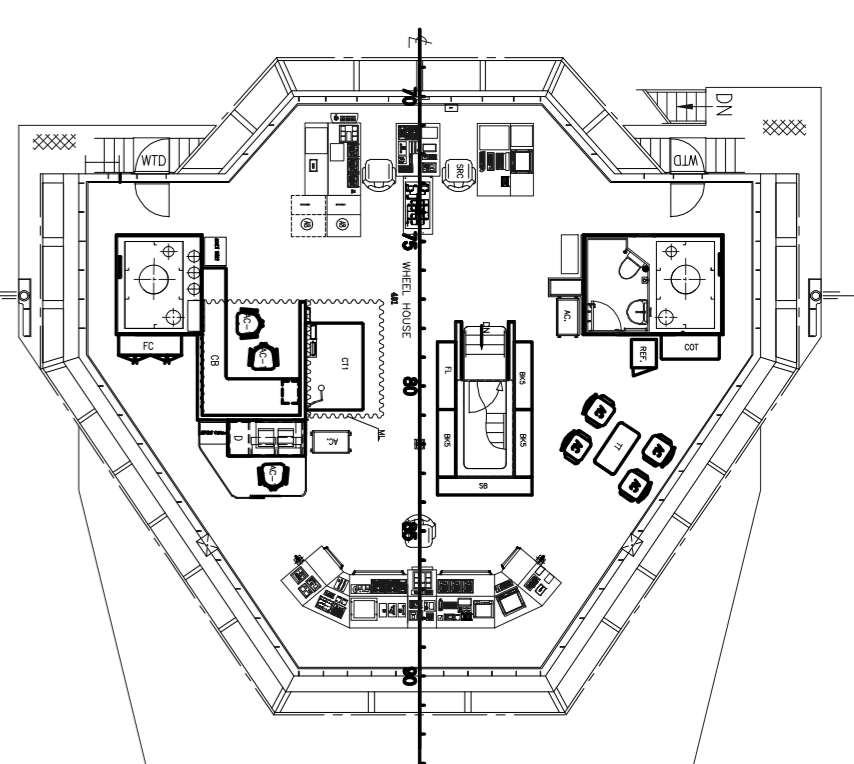

NAV. BRIDGE DECK

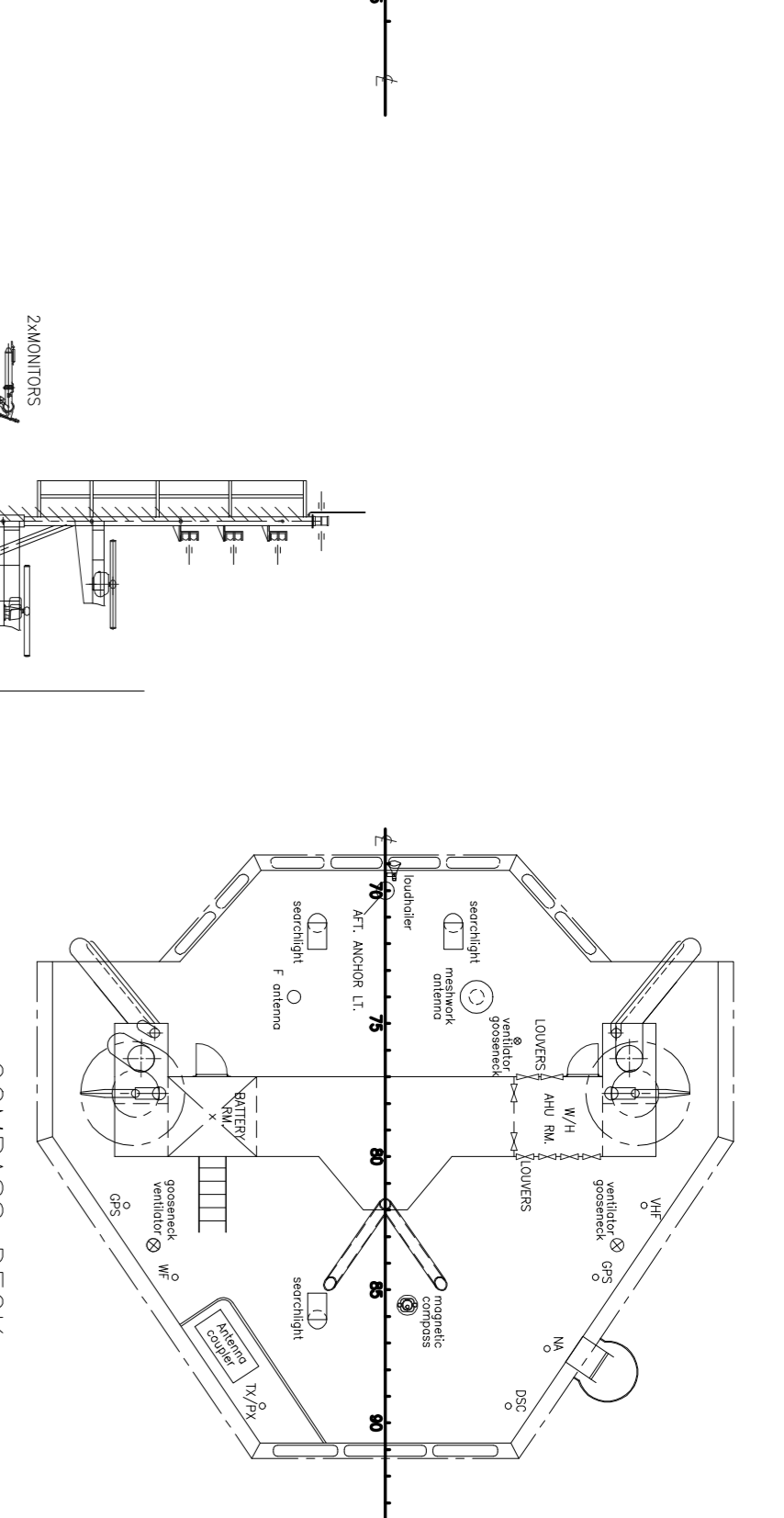

COMPASS DECK

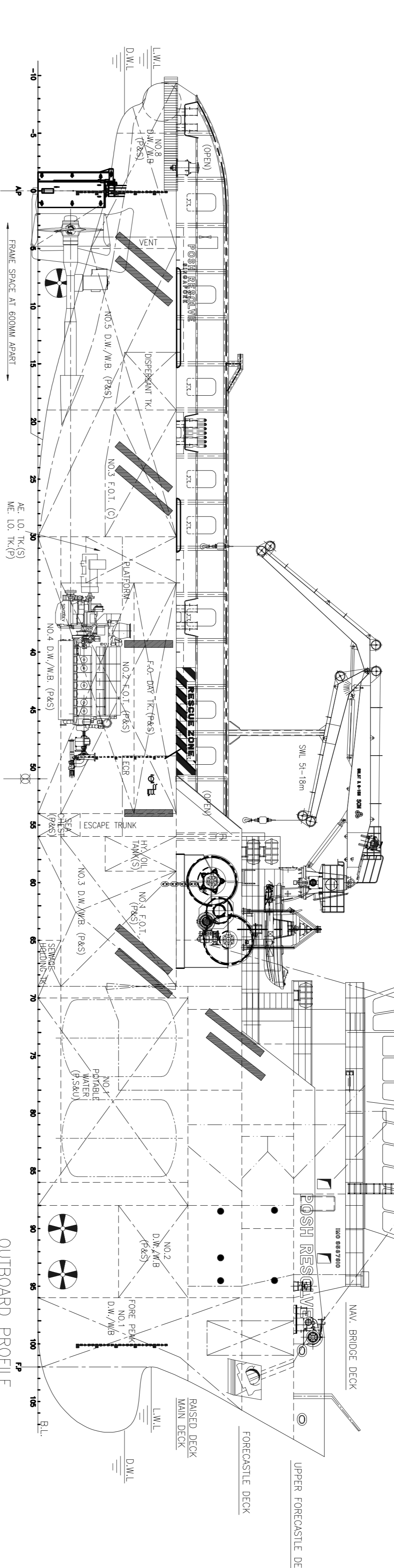

OUTBOARD PROFILE

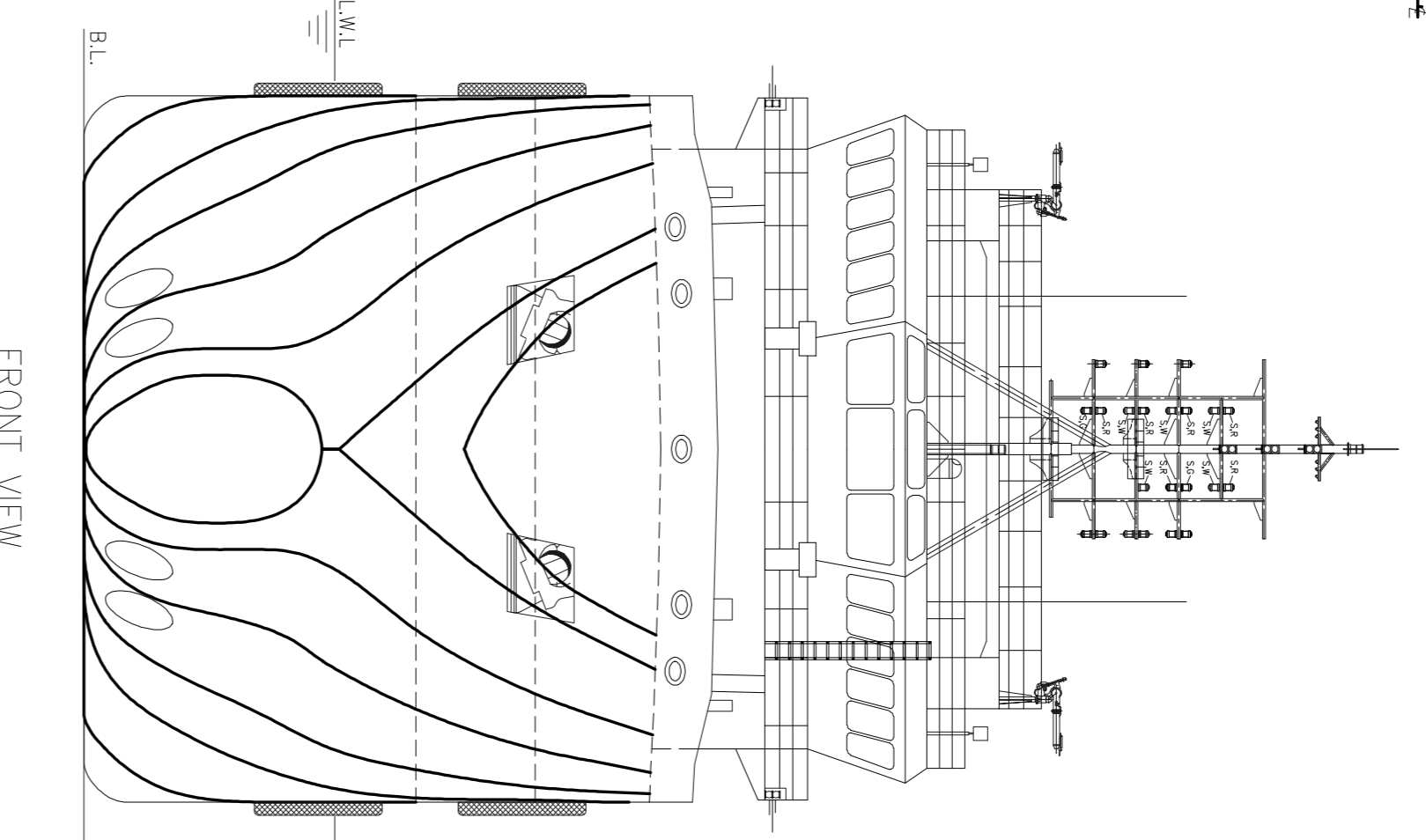

FRONT VIEW

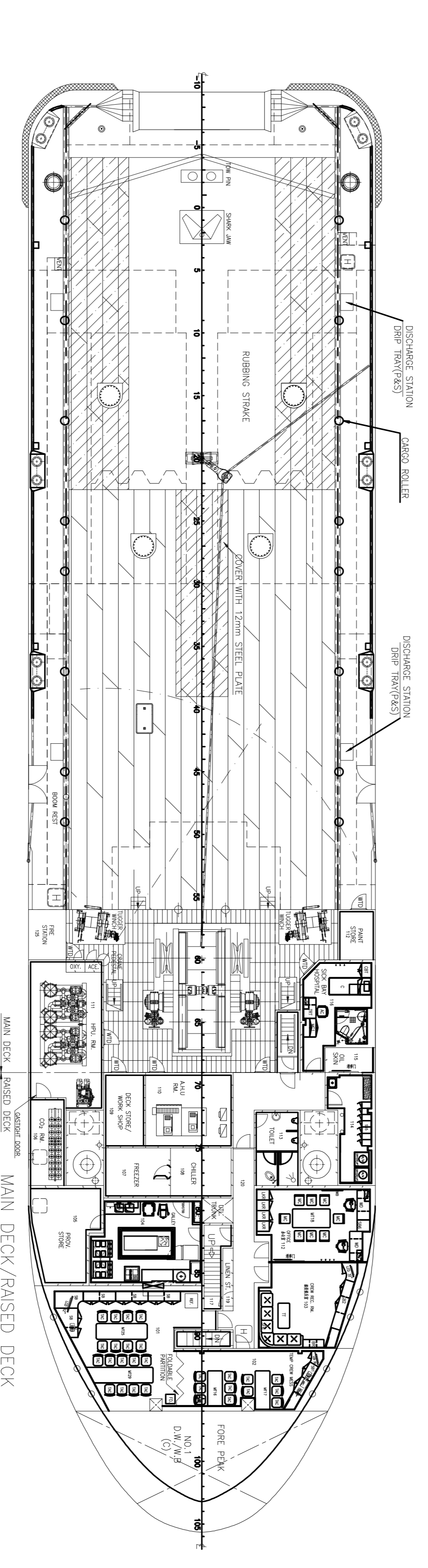

MAIN DECK/RAISED DECK

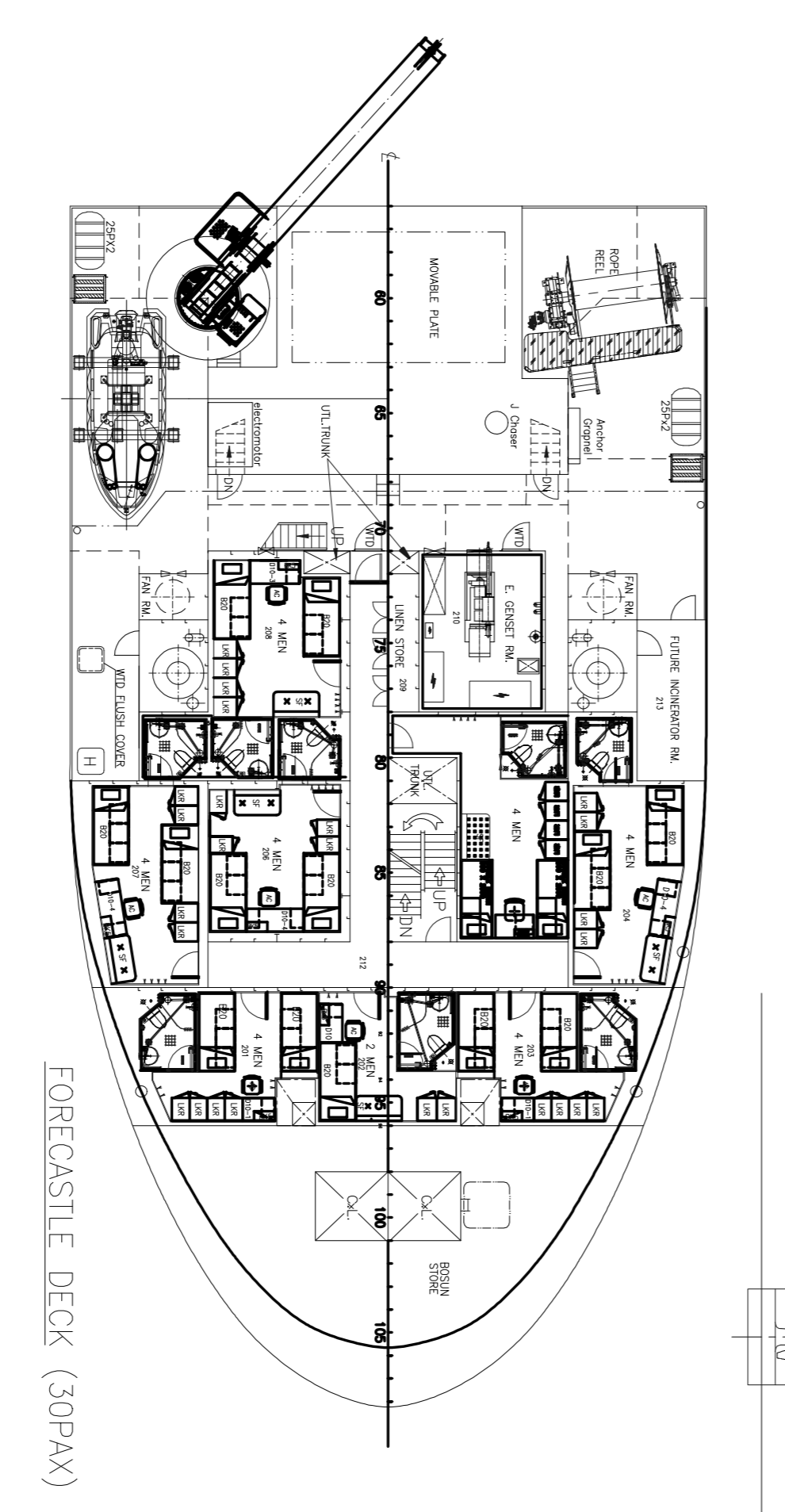

FORECASTLE DECK (30PAX)

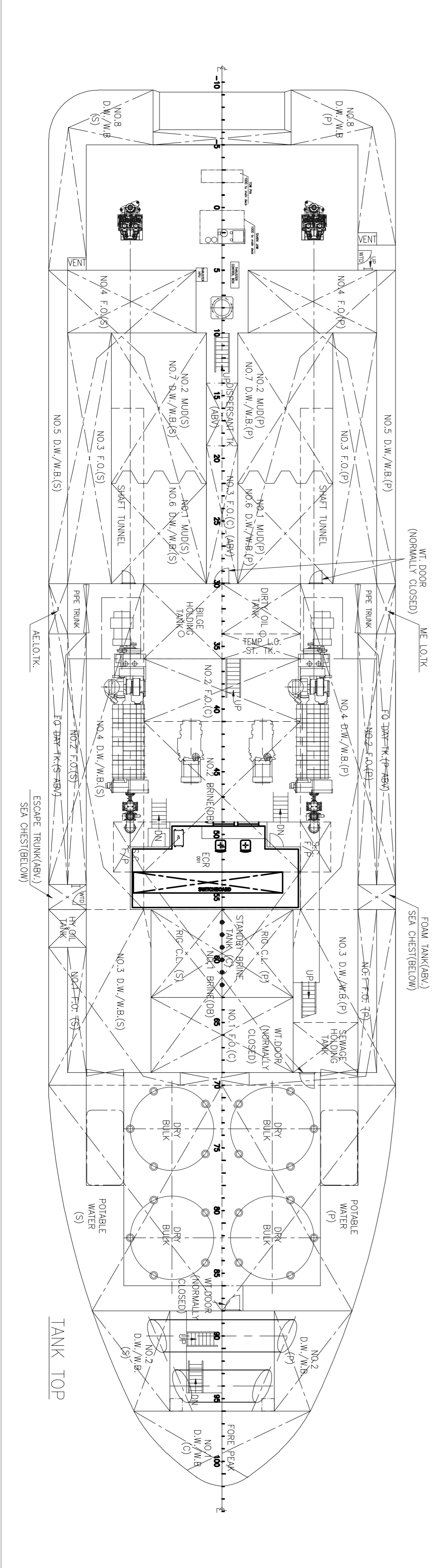

TANK TOP

PRINCIPAL PARTICULARS

- LENGTH OA \_\_\_\_\_ 71.50m
- LENGTH BP \_\_\_\_\_ 61.20m
- BEAM MLD. \_\_\_\_\_ 16.60m
- DEPTH MLD. \_\_\_\_\_ 7.20m
- DRAFT DESIGNED \_\_\_\_\_ 4.50m
- DRAFT SCANTLING \_\_\_\_\_ 5.90m
- COMPLEMENT \_\_\_\_\_ 40 MEN
- CARGO DK. LOADING \_\_\_\_\_ 101/M<sup>2</sup> FR-5~23
- \_\_\_\_\_ 51/M<sup>2</sup> FR23~56

CLASS: ABS A1 OFFSHORE SUPPORT VESSEL.  
 TONING VESSEL, FIRE FIGHTING CLASS 1  
 AMS ACCU DPS-2, ES2020

 <b>Paxocean</b> PACC OFFSHORE SERVICES HOLDINGS PTE LTD 香港太平洋新海工程有限公司 71, 81 ANDRÉ LAFAYETTE TOWER/SUPPLY VESSEL 71, 81 禧街海傍提供服務 總行 香港 日期: 2011-11-01	PROJECT: 71, 81 ANDRÉ LAFAYETTE TOWER/SUPPLY VESSEL DWG TITLE: General Arrangement 總布置圖 JOB NO. 船號: PT1003 DWG NO. 圖號: PT1003-001 CLASS 船級社: ABS SHEET NO.: 0 PAGE 頁數: SHEET 1 OF 1	 <b>Toshiba</b> TOKAI MARINE & OFFSHORE CORP. LTD